

RESIDENTIAL
RECREATIONAL

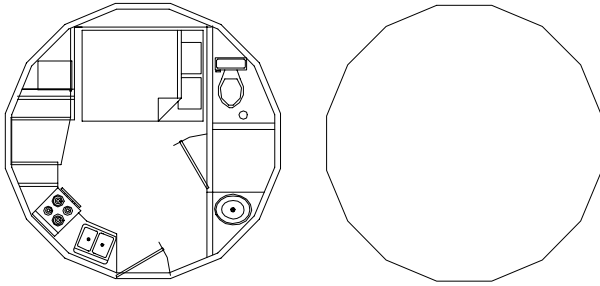

TEMPORARY SHELTER
INDUSTRIAL / COMMERCIAL

THE LOW COST-LONG LASTING-ENERGY EFFICIENT-RAPID ASSEMBLY-RELOCATABLE-LOW MAINTENANCE-STORM RESISTANT-ALTERNATIVE

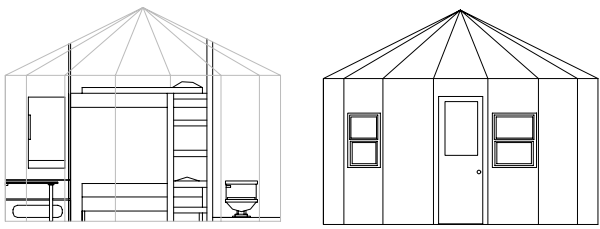

15.4' dia 181 sq.ft.

Y15.4S181A

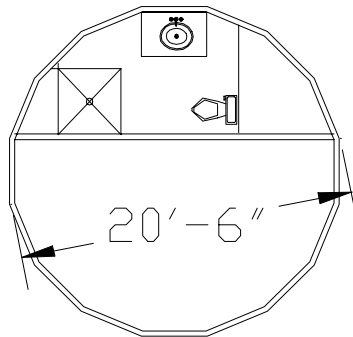

20.5' dia 321 sq.ft.

Model Y-20.5-S-321-A

Y-25.6-S-576-B

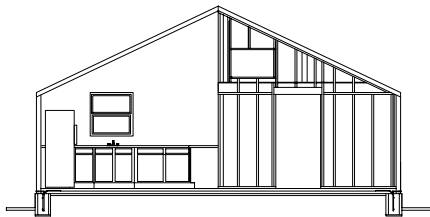

25.6' dia 503 sq.ft.

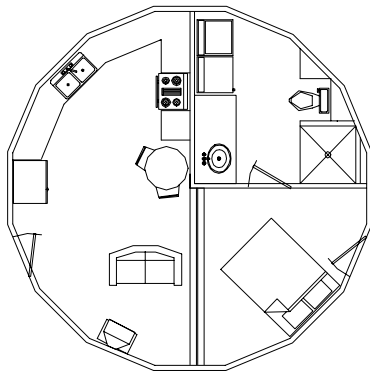

502 sq ft

Y-30.8-S-845-A

30.8' dia 724 sq.ft.

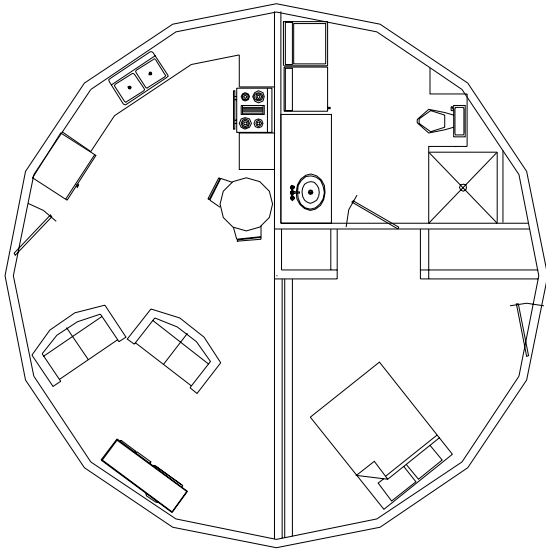

Y-35.9-S-1096-A

35.9' dia 985 sq.ft.

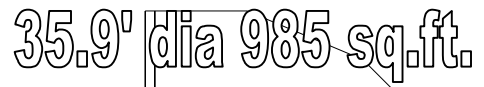
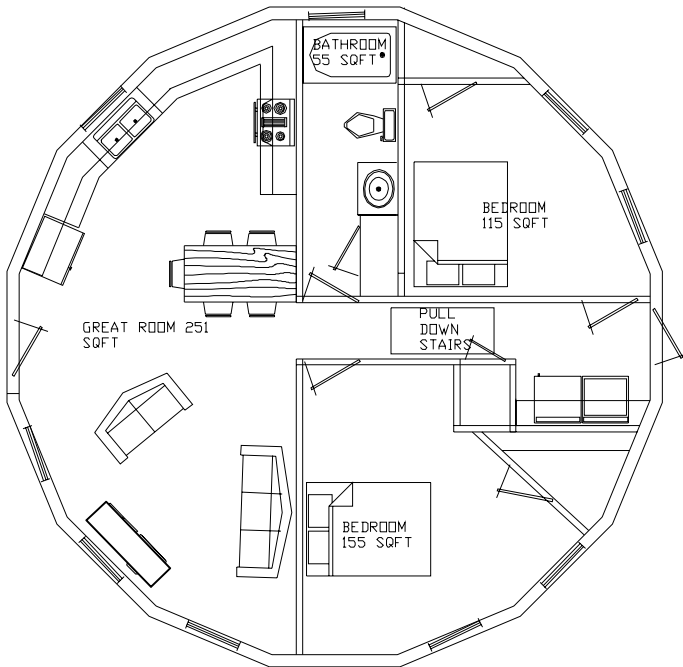

FIRST
FLOOR

LOFT
AREA

41.0' dia 1287 sq.ft.

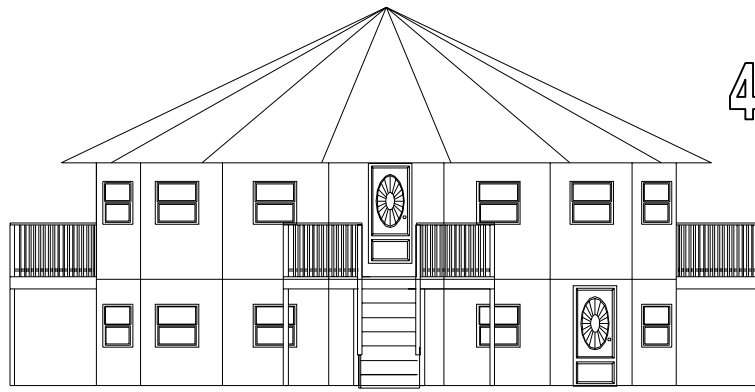

Y-41.0-S-2390-C

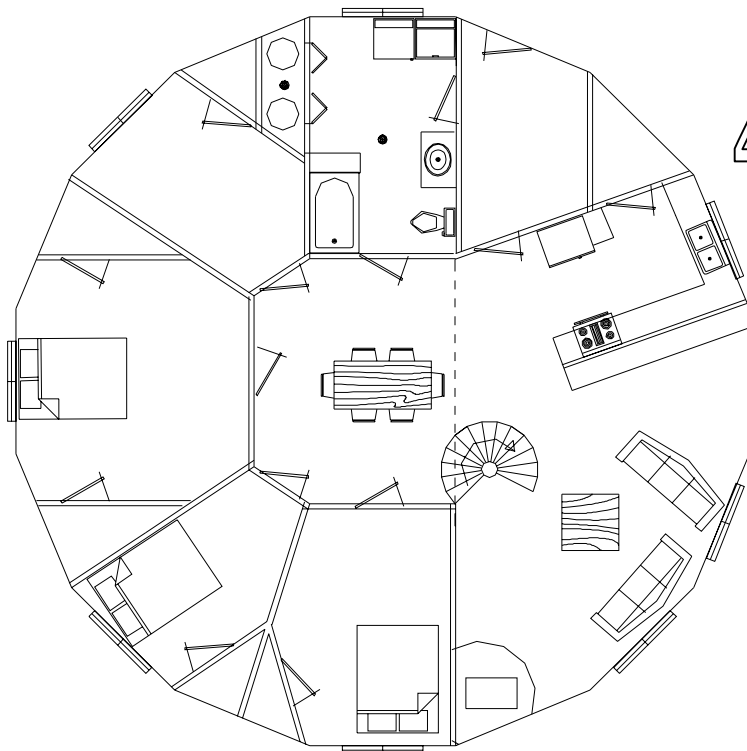
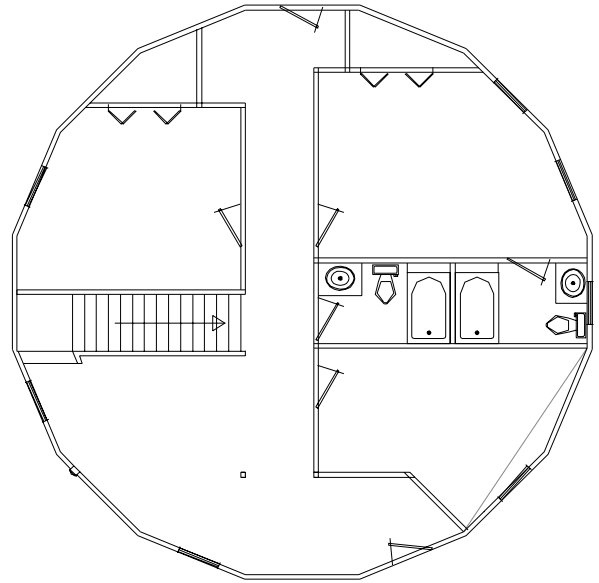
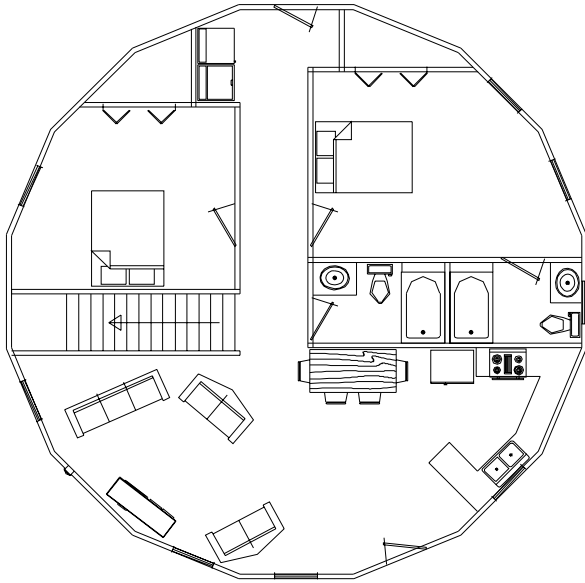

46.1' dia 1629 sq.ft.

Y-46.1.-S-2174-A

Y- 51.3-S-2656-A

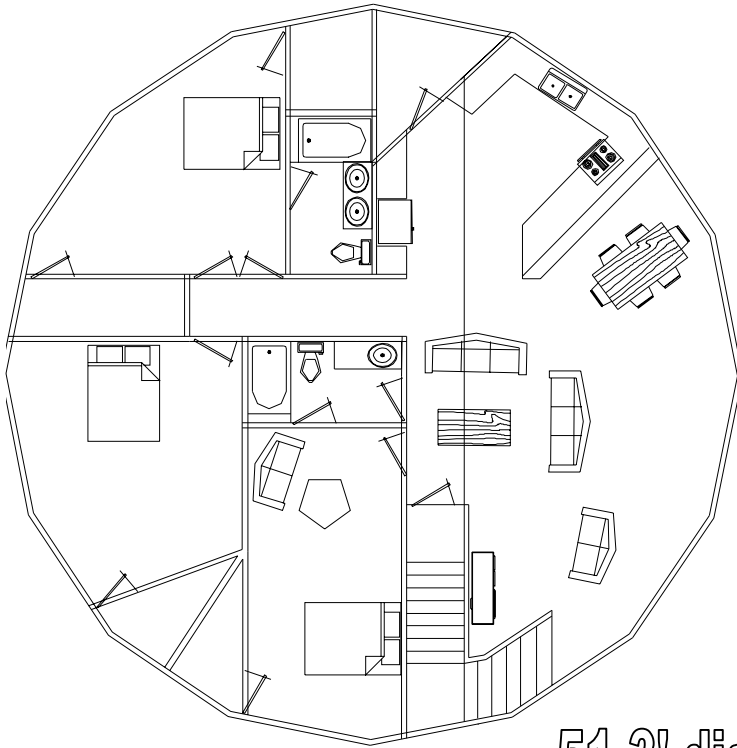

LOFT 1980 SQ.FT.

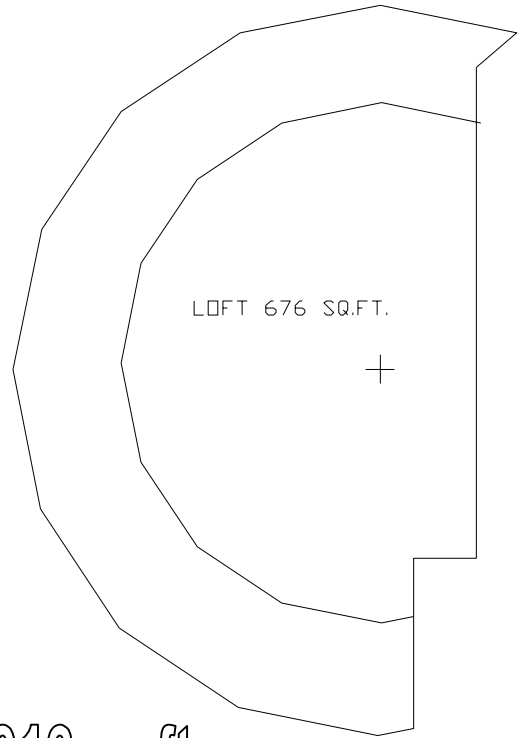

51.3' dia 2010 sq.ft.

There are the 8 sizes of the units we carry above. We can provide options in the units with taller walls for two story units we can connect units with breeze ways and we provide individualized plans for each unit as part of the kit. The interior framing, plumbing, electrical, drywall, cabinets, doors are all the same as a conventional stick built structure.